

VERGLASS°

hand made in France



VERGLASS°

hand made in France



Glow

Composé de trois éléments en verre soufflé, et à partir de sept couleurs de base le modèle Glow associe un design sobre et des teintes subtiles, mises en valeur par superposition.

Options :

Chaque modèle peut être choisi soit entièrement transparent ou avec la partie basse dépoli ce qui permet de cacher l'ampoule et supprimer l'éblouissement.

D'autres longueurs de tube inox sont disponibles sur simple demande.

Possibilité de montage sur câble textile, huit couleurs disponibles.

Finition douille et plafonnier métal : nickel poli, laiton vieilli, laiton poli.

VERGLASS°

hand made in France



Transparent

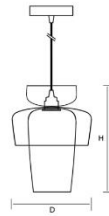

Glow
Hauteur : 280 mm
Diametre : 210 mm

Dépoli intérieur

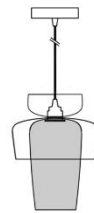

Apricot

Olivin

Stahlblau

Aquamarineblau

Goldtopaz

Turkisblau

Annagrun

VERGLASS°

hand made in France



Bloom

Assemblage vif et amusant , jouant entre couleur et texture.
Décoratif et fonctionnel.

3 modèles sont disponibles.

Options :

Finition métal : nickel poli, laiton vieilli, laiton poli.

Couleur de câble : huit couleurs disponibles.

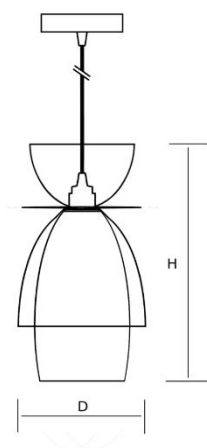

Hauteur : 390 mm — Diametre : 150 mm

VERGLASS°

hand made in France



Blossom

La rosée du matin, la délicatesse et la douceur sont la source d'inspiration pour ce modèle.

Options :

Couleur : turquoise, topaze, abricot, olivin, bleu acier.

Finition métal : nickel poli, laiton vieilli, laiton poli.

Couleur de câble : huit couleurs disponibles.

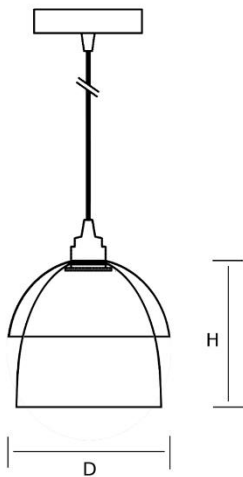

Hauteur: 180 mm — Diametre : 160 mm

VERGLASS°

hand made in France



Azur

Ce modèle existe uniquement dans ces couleurs flamboyantes rouge, dorée accompagné de gris fumée. Trois formes sont disponibles.

Options :

Finition métal : nickel poli, laiton vieilli, laiton poli.

Couleur de câble : huit couleurs disponibles.

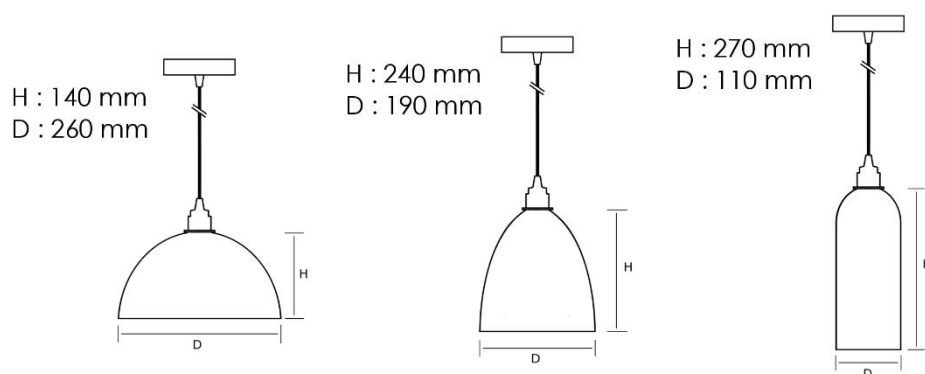

VERGLASS°

hand made in France



Lotus

Fleur de lotus, scarabée ? La nature a inspiré cette composition de quatre éléments en verre soufflé. Comme s'il déployait ces ailes. Lotus donne l'impression de papillonner dans les airs.

Options :

Couleur du verre : dix couleurs possible.

Finition métal : nickel poli, laiton vieilli, laiton poli.

Couleur de câble : huit couleurs disponibles.

VERGLASS°

hand made in France

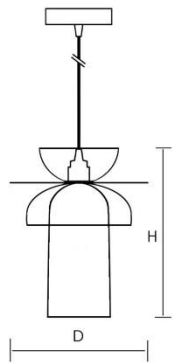

Lotus 1
Height: 300 mm
Diameter: 230 mm

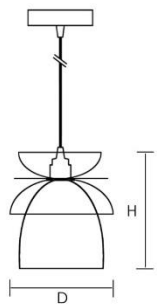

Lotus 2
Height: 230 mm
Diameter: 210 mm

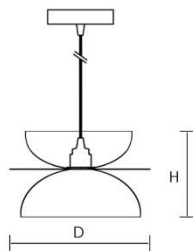

Lotus 3
Height: 170 mm
Diameter: 250 mm



Glass colours



Apricot



Olivin



Stahlblau



Aquamarineblau



Goldtopaz



Meeblau



Grey

VERGLASS°

hand made in France

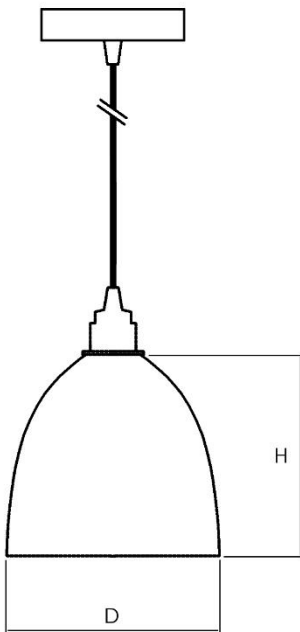

Hauteur : 160mm — Diametre : 160mm

Basic

Une forme simple, délicatement coloré notre modèle Basic peut aussi devenir l'élément essentiel d'un escalier ou le centre d'une pièce en associant plusieurs luminaires.

Options :

Couleur du verre : dix couleurs possible.

Finition métal : nickel poli, laiton vieilli, laiton poli.

Couleur de câble : huit couleurs disponibles.

VERGLASS°

hand made in France



Pop

Avec ses couleurs vives et lumineuses, ce modèle donne vie et pep's dans toutes les pièces.

Sur ce luminaire des pastilles de verre colorées translucides sont appliquées, à chaud, sur un fond en verre blanc opaque, ce qui lui donne des couleurs profondes et intenses.

Options :

Couleur du verre : combinaison de trois couleurs sur fond blanc, nombreuses possibilités sur demande.

Finition métal : nickel poli, laiton vieilli, laiton poli.

Couleur de câble : huit couleurs disponibles.

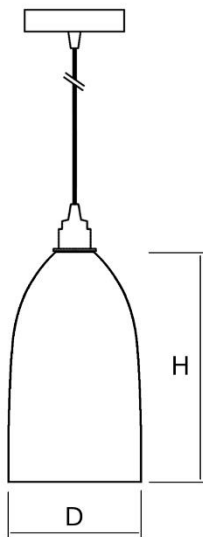

Hauteur : 260 mm — Diametre : 150 mm

VERGLASS°

hand made in France

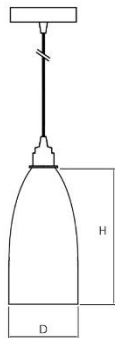

Slim shape
Height: 140mm
Diameter: 280mm

Modèle présenté :
meerblau - goldtopaz -
trait blanc

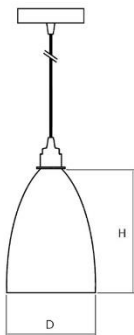

Demi curve
Height: 140mm
Diameter: 280mm

Modèle présenté:
aquamarinblau - olivin - trait
blanc
aquamarinblau - goldtopaz
- trait blanc

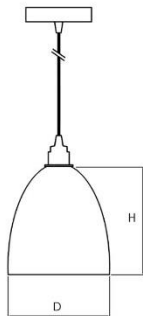

Grand curve
Height: 140mm
Diameter: 280mm

Modèle
présenté:
olivin - apricot -
trait blanc



Glass colours



Apricot

Olivin

Stahlblau

Aquamarineblau

Goldtopaz

Meeblau

Grey

VERGLASS°

hand made in France



Cal

Cet élégant luminaire combine deux couleurs qui sont assemblées avec beaucoup d'attention pendant le processus de fabrication à chaud, un fin cordon de verre noir ou blanc donne la dernière touche. Il existe en trois formes du plus fin au plus large.

Options

Couleur du verre : sept couleurs possible ce qui fait treize combinaison différentes .

Finition métal : nickel poli, laiton vieilli, laiton poli.

Couleur de câble : huit couleurs disponibles.

VERGLASS°

hand made in France



Lino

Fait à la main, la ligne de verre noir sur le modèle Lino est comme une signature, le geste qu'on ne peut dupliquer, ce qui en fait une pièce unique. Sa forme vintage et chic est parfaite pour une ambiance cosy.

Options

Couleur du verre : sept couleurs possible.

Finition métal : nickel poli, laiton vieilli, laiton poli.

Couleur du câble : huit couleurs disponibles.

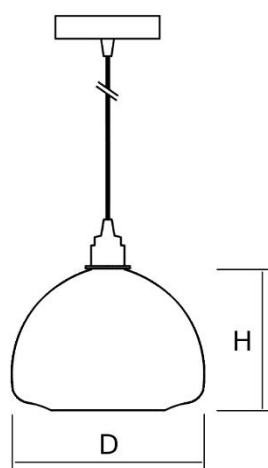

Hauteur : 150 mm — Diametre : 210 mm

VERGLASS°

hand made in France

Finition douille et plafonnier métal :

Laiton vieilli



Nickel polis



Laiton polis



Cordon textile 3 fils tressés

Gold - Doré



Black - Noir



Burgundy - Bordeaux



Antique - Marron



Teal - Turquoise



Brown - Brun



Sage - Saugé



Grey - Gris

